

---

**USER MANUAL**  
Dishwasher  
EN

DBI343ID.W.AU  
DBI343ID.S.AU

# Contents

<b>Your dishwasher</b> .....	<b>3</b>	For the best drying results .....	19
<b>Safety instructions</b> .....	<b>4</b>	Unloading the dishwasher .....	19
Child lock .....	5	<b>Program chart</b> .....	<b>20</b>
Installation .....	5	<b>Settings</b> .....	<b>21</b>
Overflow guard .....	5	<b>Care and cleaning</b> .....	<b>23</b>
Winter storage/Transport .....	5	Top up rinse aid .....	23
Packaging .....	6	Clean the filters .....	23
Disposal .....	6	Cleaning the spray arms .....	25
Symbols .....	6	Clean the outside of the dishwasher .....	26
<b>Before washing for the first time</b> .....	<b>7</b>	Run Self-cleaning .....	26
Water hardness .....	7	Remove blockages .....	26
Basic settings .....	7	<b>Troubleshooting</b> .....	<b>28</b>
Top up rinse aid .....	8	<b>Installation</b> .....	<b>35</b>
<b>Greener dishwashing</b> .....	<b>9</b>	Safety instructions .....	35
Save energy and water .....	9	Transport protection for the door .....	36
<b>Loading the dishwasher</b> .....	<b>10</b>	Placing the dishwasher .....	36
Fragile dishes .....	10	Affix the protective film .....	36
Loading affects the results .....	10	Adjust the height and slide the dishwasher into place .....	37
The dishwasher baskets .....	11	Drainage connection .....	38
Upper basket .....	11	Connection to water supply .....	39
Lower basket .....	12	Electrical connection .....	40
Cutlery basket .....	13	Screwing the dishwasher into place .....	40
<b>Using the dishwasher</b> .....	<b>15</b>	Dishwasher kick panel .....	41
Add detergent .....	15	<b>ASKO Service</b> .....	<b>42</b>
On/Off .....	16	Information about your product .....	42
Select program .....	16	Contact your nearest service centre .....	42
Select program mode .....	17	Number of cycles .....	42
Select option .....	18	<b>Technical information</b> .....	<b>43</b>
Start/Stop .....	18	Information on energy labelling .....	43
If you want to load more dishes .....	19	Technical data .....	43
Power failure .....	19	Information for test institute .....	43
Once the program has finished .....	19		

# Your dishwasher

Welcome to our growing ASKO family!

We are proud of our appliances. We hope that this appliance will be an appreciated and dependable aid for many years to come.

Please read the operating instructions before use. They include general tips, information about the settings and adjustments you can make, and the best way to take care of your appliance.

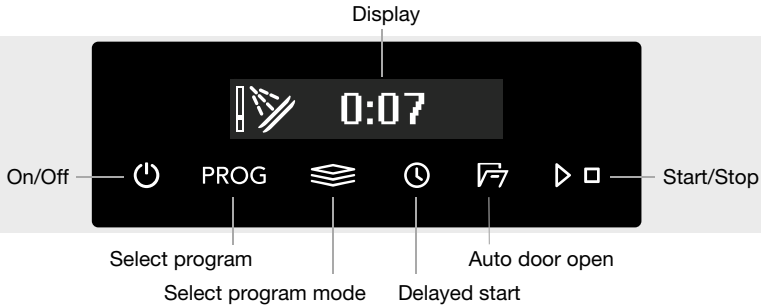

Symbols on the display:

- ↗ Auto door open
- \* Top up rinse aid

Text on the display:

- Clean the filters
- Run Self-cleaning
- See the chapter, *Care and cleaning*.

To install the dishwasher see the chapter, *Installation*. Then press .

**"Welcome to your ASKO. First time setup."** is shown on the display the first time the dishwasher is switched on. It is important that you choose the right settings to ensure good dishwashing results. See page 7.

# Safety instructions

- Read the operating instructions and keep them in a safe place!
- Number of place settings: 14
- Never use the dishwasher for any purpose other than that specified in these operating instructions.
- Do not load the dishwasher door or dishwasher baskets with anything other than dishes.
- The door should not be left in the open position since this could present a tripping hazard. Push the baskets in to avoid the risk of the dishwasher tipping over.
- Use only dishwasher detergent!
- This appliance is not intended for use by persons (including children) with reduced physical, sensory or mental capabilities, or lack of experience and knowledge, unless they have been given supervision or instruction concerning use of the appliance by a person responsible for their safety.
- If the supply cord is damaged, it must be replaced by the manufacturer, its service agent or similarly qualified persons in order to avoid a hazard.
- Any damaged cords must only be replaced by the manufacturer's service centre or someone with similar professional qualifications.
- This appliance is intended to be used in household and similar applications such as:
  - staff kitchen areas in shops, offices and other working environments;
  - farm houses;
  - by clients in hotels, motels and other residential type environments;
  - bed and breakfast type environments.
- Never place dishes with solvent residues in the dishwasher due to the risk of explosion. Nor may dishes that contain ash, wax or lubricants be washed in the dishwasher.

- Children should be supervised to ensure that they do not play with the appliance.
- Children must be watched. Do not allow children to use or play with the dishwasher. Be especially vigilant when the door is open. Some detergent may remain inside! After adding detergent, always start the dishwasher immediately.

## WARNING!



Knives and other utensils with sharp points must be loaded in the basket with their points down or placed in a horizontal position.

## WARNING!

Dishwasher detergents are strongly alkaline. They can be extremely dangerous if swallowed. Avoid contact with skin and eyes and keep children away from the dishwasher when the door is open. Seek medical attention if swallowed.

Check that the detergent compartment is empty after completion of the wash cycle.

## Child lock

You can activate the Automatic child lock setting to prevent children from starting the dishwasher. See the chapter, *Settings*. You can also temporarily activate and deactivate the Child lock function. Press and hold  and  for three seconds.

## Installation

See the chapter *Installation*.

## Overflow guard

The overflow guard starts pumping water out of the water and turns the water supply off if the water level in the dishwasher exceeds the normal level. If the overflow guard is triggered, F54 (Overfilling water) appears on the display. Turn the water tap off and contact your nearest service centre. (To avoid water leaking outside the dishwasher, do not remove the plug from the wall socket until the water tap to the supply line has been turned off!)

## Winter storage/Transport

Store the dishwasher above freezing temperature and avoid long transport distances in very cold weather. Transport the dishwasher upright or laying on its back.

# Safety instructions

Water must be removed from the machine before the dishwasher is transported anywhere or before being stored for long periods.

## Packaging

The outer packaging protects the product during transport. The packaging material is recyclable. Separate the different packaging materials to help reduce raw material use and waste. Your dealer can take the packaging for recycling or direct you to the nearest recycling centre. The packaging is comprised of:

- Corrugated cardboard made from up to 100% recycled material.
- Expanded polystyrene (EPS) with no added chlorine or fluorine.
- Supports made from untreated wood.
- Protective plastic made from polyethylene (PE).

## Disposal

The dishwasher is manufactured and labelled for recycling. When the dishwasher has reached the end of its service life and is to be disposed of, it should immediately be made unusable. Pull the power cable out and cut it to the shortest length possible.

Contact your local authority for information about where and how your dishwasher should be correctly recycled.

## Symbols

Explanation of symbols that may appear on the appliance.



Read the User Manual.

# Before washing for the first time

## Water hardness

In order to achieve good dishwashing results, the dishwasher needs soft water (water with low mineral content). Hard water leaves a white coating on dishes and the dishwasher.

### Checking water hardness

Contact the local water utility to check the water hardness in your area. This is important with regard to how much detergent and rinse aid to use.

## Basic settings

Press .

"**Welcome to your ASKO. First time setup.**" is shown on the display. It is important that you choose the right settings to ensure good dishwashing results.

Select setting with **PROG**. Confirm selected setting with .

Settings		
1.	<b>Language</b>	Select the language to be shown on the display.
2.	<b>Set level of rinse aid</b> 0/1/2/3/4/5 <i>Pre-selected at factory: 4</i>	By using rinse aid you will improve your drying result. You will also achieve a better dishwashing result with glassware and dishes. The rinse aid dispenser can be adjusted between 0 (Off) and 5 (High dose).
3.	<b>TAB On/Off</b> <i>Pre-selected at factory: Off</i>	Activate this setting when using an all-in-one detergent that contains rinse aid. This setting reduces the rinse aid dose.

To change the chosen setting, see the chapter *Settings*.

# Before washing for the first time

## \* Top up rinse aid

Top up the rinse aid compartment with rinse aid if you have selected Rinse aid 1 - 5.

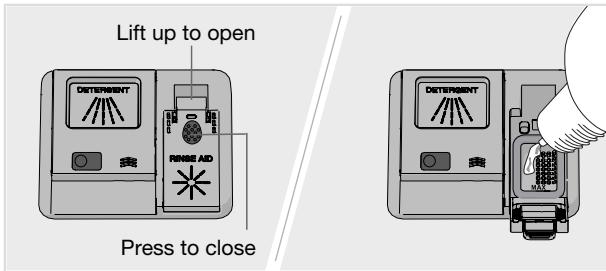

1. Open the rinse aid compartment lid.
2. Carefully top the rinse aid up to the marked level **MAX**.
3. Wipe up any splashes of rinse aid around the compartment.
4. Close the lid firmly.

For water with a hardness greater than 10–12 °dH, you ought to use rinse aid with citric acid (known as acid rinse aid).



## Save energy and water

When using a dishwasher in a residential setting, less energy and water are generally used compared to washing the dishes by hand.

### **Do not rinse under running water**

Do not rinse the dishes under running water as this will lead to increased energy and water consumption. Simply scrape off large food particles before loading the dishwasher.

### **Choose a green detergent**

Read the environmental declaration on the packaging!

Too much detergent and rinse aid can result in less effective dishwashing and also entail greater environmental impact.

### **Run a fully loaded dishwasher**

Save energy and water by waiting until the dishwasher is full before running a program. Use the Rinse and hold program to rinse the dishes if there are any unpleasant odours.

You can also use the Anti-odour program to prevent bad odours from dirty dishes left in the dishwasher.

### **Run programs at a lower temperature**

If the dishes are only slightly dirty, you can select a program with a low temperature.

### **Select dishwashing program – Eco**

Use when you want to save water and energy. For normally soiled load, such as plates, serving dishes, cups, glasses and so on.

This dishwashing program is designed for an effective wash using as little energy and water as possible. The program washes at a low temperature for a long time.

### **Select option – Auto door open**

Better drying results are achieved if you use the Auto door open option, which automatically opens the dishwasher door. Wait until the dishwasher indicates that the program has ended and the dishes have cooled before unloading the dishwasher.

# Loading the dishwasher

## Fragile dishes

Some cookware is not dishwasher safe. This can be for several reasons. Some materials cannot withstand high heat, others can be damaged by dishwasher detergent.

Exercise caution with, for example, handmade items, fragile decoration, crystal/glassware, silver, copper, tin, aluminium, wood and plastic. Look for the "Dishwasher safe" marking.

### **Fragile decoration**

Porcelain with decoration on top of the glazing (the items feel rough) should not be washed in a dishwasher.

### **Crystal/Glass**

By using rinse aid you will improve your drying result. You will also achieve a better dishwashing result with glassware and dishes.

*Hand-painted glassware, as well as antique and very fragile items, should not be washed in a dishwasher.*

### **Silver**

Silver and stainless steel items should not come into contact, as the silver can become discoloured.

In order to avoid marks and tarnishing, separate dishes made from different metals, such as silver, stainless steel and aluminium.

### **Aluminium**

Aluminium can lose its shine if washed in a dishwasher. However, good quality aluminium pans can be washed in a dishwasher, even if some of the shine will be lost.

### **Cutlery with glued handles**

Some types of glue are not dishwasher safe. In such cases, the handles may loosen.

## Loading affects the results

Load the dishes carefully to ensure the best washing and drying results with the lowest possible energy and water consumption. Give your dishwasher the best chance to reach and clean all surfaces, as well as to dry the dishes as thoroughly as possible.

- All dirty surfaces should face inwards and downwards!
- Dishes should not be placed in or on each other.
- Angle dishes with hollows, such as cups, so that the rinse water will run off. This is also important for plastic items.
- Make sure small items cannot fall through the dishwasher basket; place them in the cutlery basket.

## NOTE!

Check that the spray arms can rotate freely.

## The dishwasher baskets

The dishwasher is equipped with an upper basket and a lower basket with a cutlery basket.

*The appearance of the baskets may differ depending on the dishwasher setup.*

## Upper basket

Place glasses, cups, bowls, side plates and saucers in the upper basket. All dirty surfaces should face inwards and downwards! Place wine glasses on the wine glass shelf and knives in the knife stand on the right.

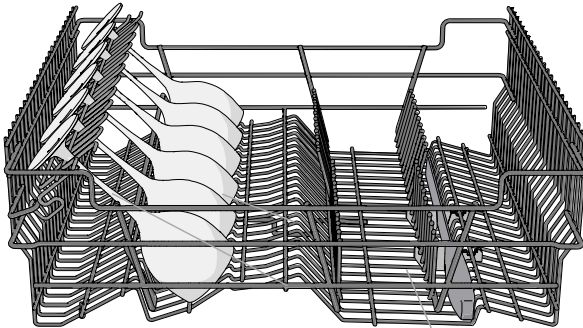
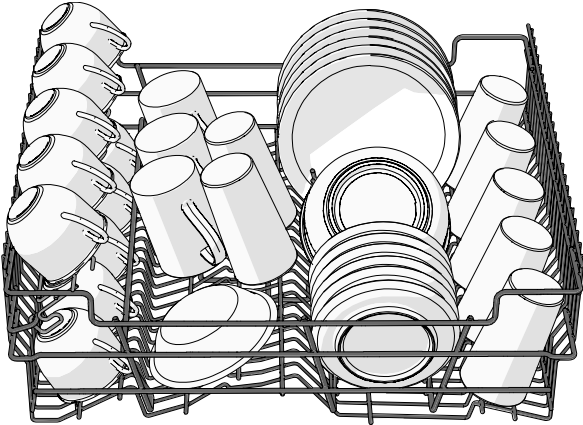

Knife stand

## Raising and lowering the upper basket

1. Pull out the upper basket. (The basket must be empty.)
2. Turn the basket catch outwards at the end of both runners.
3. Grip the upper basket with both hands, pull it out, and move the upper basket to its other position.
4. Turn the basket catch on either side in to lock the basket in place.

# Loading the dishwasher

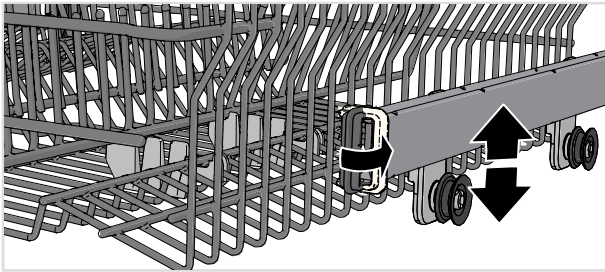

## Lower basket

Place plates, side plates, serving dishes, pots and cutlery (in the cutlery basket) in the lower basket.

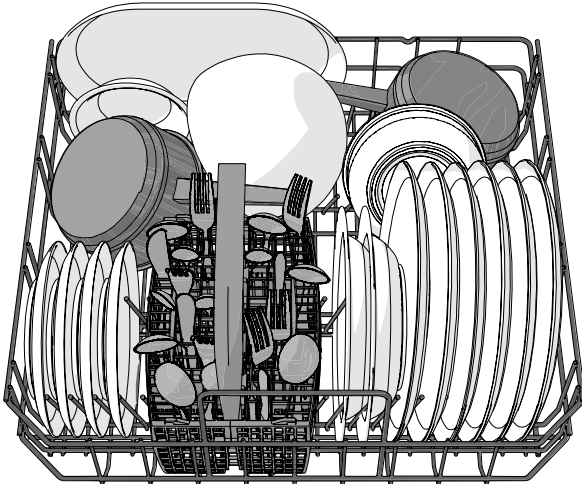

## Accessory

Buy a wine glass shelf with space for six tall<sup>1)</sup> wine glasses. The wine glass shelf is designed to ensure optimal washing and drying results with tall wine glasses. The wine glass shelf is placed in the rear section of the lower basket. This accessory can be purchased by calling ASKO.

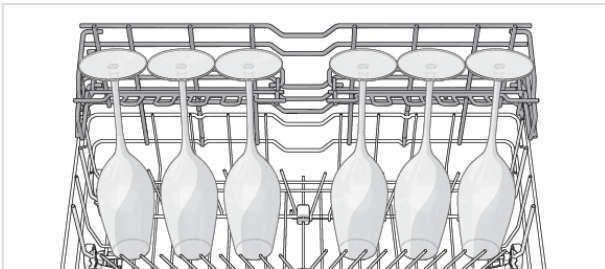

<sup>1)</sup> Height: max. 25 cm, Diameter: max. 7.5 cm

## Cutlery basket

Place cutlery with the handles facing down, except for knives, and spread them out as much as possible. Ensure that spoons do not stack inside each other.

The cutlery basket is best placed in the middle at the front of the lower basket to achieve the best dishwashing performance from the unique spray nozzle, which is intended for the cutlery basket.

### WARNING!

Knives and other sharp must be placed horizontally in the dishwasher's special cutlery baskets to prevent damage to the dishwasher tub and risk of cut type injuries.

### Fold-down section for small items

The cutlery basket has a fold-down section in the middle for small items or small shafts (such as electric whisk attachments).

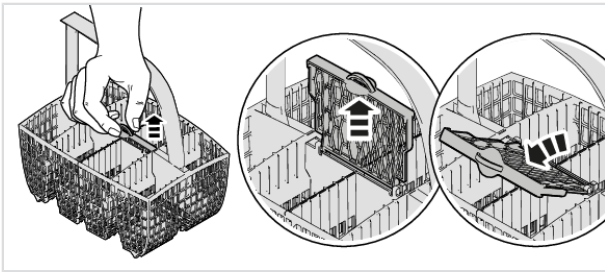

### Cutlery basket with lid

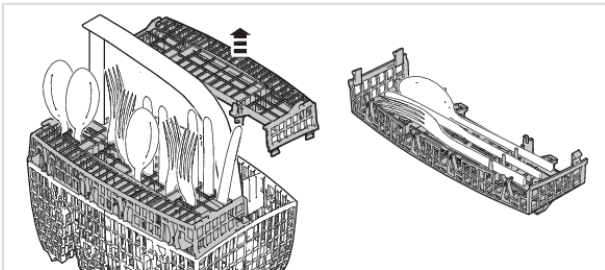

# Loading the dishwasher

## Accessory

Buy a mini cutlery basket. The extra cutlery basket is flexible and can be dismantled and attached to the lower basket or the large cutlery basket to make an extra large cutlery basket. This accessory is available where you bought the dishwasher.

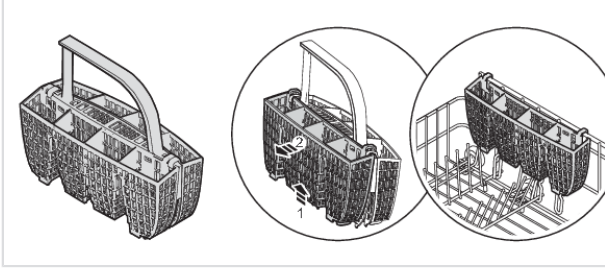

## Add detergent

Follow the instructions on the detergent packaging.

Too much detergent can result in less effective dishwashing and also entails greater environmental impact.

### Detergent compartment

The detergent compartment must be dry when adding detergent.

If powder or liquid dishwasher detergent is used, add a small amount of the detergent to the prewash detergent compartment.

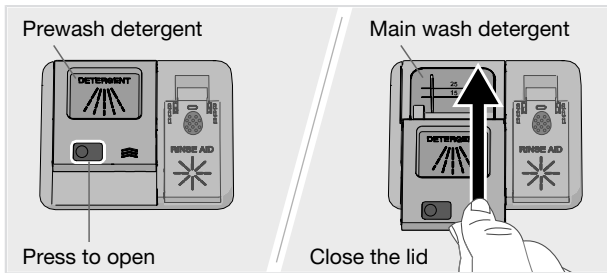

### NOTE!

Use only dishwasher detergent! Washing up liquid must not be used as the foam that forms prevents the dishwasher from operating effectively.

### All-in-one detergent

There are many types of all-in-one detergents on the market. Read the directions for these products carefully.

Activate the TAB setting when using an all-in-one detergent that contains rinse aid.

Dishwasher tablets are not recommended for short programs (less than 75 minutes). Use powder or liquid dishwasher detergent instead.

### NOTE!

Optimum washing and drying results are achieved by using normal dishwasher detergent together with separately dispensed rinse aid.

Contact the detergent manufacturer if you have any questions about the detergent.

# Using the dishwasher

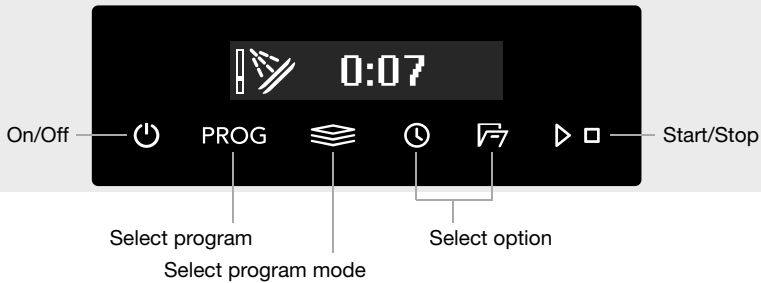

## On/Off

Press . Also turn the water tap on if it is turned off.

## PROG Select program

To select a program, press the navigation button **PROG** until the desired program is shown on the display.

Select a program to suit the type of dishes and how dirty they are.



### **Eco**

Use when you want to save water and energy. For normally soiled load, such as plates, serving dishes, cups, glasses and so on.

You can read more about greener dishwashing in the chapter *Greener dishwashing*.



### **Heavy**

Use to wash heavily soiled load, such as plates, serving dishes, cups, glasses and so on.



### **Intensive**

A program with a high temperature for dissolving grease on very dirty dishes such as pans, casserole dishes and oven dishes. If these dishes do not completely fill the dishwasher, you can add plates and other dishes.



### **Quick<sup>2)</sup>**

A fast and effective program for slightly dried leftovers. (This program is not intended for burnt food such as on oven dishes.)

The Auto door open option is important for ensuring the best drying results.

<sup>2)</sup> When combined with Speed, the program is shortened (60 minutes).





## Time program

The program adapts to the specified running time or finish time. With this program it is important to choose a time suited to how dirty the dishes are.

Press  to set the desired program time.

0:15-0:45	Slightly dirty dishes
1:00-1:30	Normally dirty dishes
2:00-2:30	Very dirty dishes



## Hygiene

This program is designed to meet strict hygiene demands.



## Rinse and hold

Used to rinse dishes while you wait for the dishwasher to become fully loaded.



## Self-cleaning

Self-cleaning program for hygienic cleaning of the dishwasher tub, spray arms and spray pipes.

This program should be run (with no dishes in the machine) using normal dishwasher detergent or citric acid. Special dishwasher cleaners are also available on the market. For the removal of lime scale deposits, see *Dishwasher tub* in Chapter *Care and cleaning*.

**72h**

## Anti-odour<sup>3)</sup>

This program prevents bad odours from dirty dishes left in the dishwasher. Only the dishwasher fan is activated (at regular intervals during a period of 72 hours).



## Select program mode

Press  to scroll through the available program modes. The symbol is dimly lit in available program modes and glows brighter when a program mode has been activated. (The program modes you can select vary between programs.)

## ▶▶ Speed

The program time is shortened, but the dishwasher uses more energy.



## ☾ Night

Lower noise level during the dishwashing program. The program time is extended.

<sup>3)</sup> Activate Odour control in the dishwasher Settings menu. See the Settings chapter.

# Using the dishwasher

## Select option

Available options are dimly lit. Select the options (  ,  ) to activate them. The options glow brighter when activated. (The options you can select vary between programs.)

### **Auto door open**

The dishwasher door opens automatically, which shortens the program time and improves the drying results. Wait until the dishwasher indicates that the program has ended and the dishes have cooled before unloading the dishwasher.

The drying time for the Auto door open option varies (from 5 to 90 minutes) depending on the model, program and temperature of the final rinse.

The Auto door open option is pre-selected for some programs.

### NOTE!



For the best drying results, do not close the door before the drying phase has finished and the machine has automatically switched off.

### WARNING!

The dishwasher door must not be blocked or closed when opened automatically. Doing so may damage the door lock mechanism. Wait at least 5 minutes before closing the door.

### **Delayed start**

When you select Delayed start, the dishwasher will start 1–24 hours after you press the .

1. Press  once to activate Delayed start. To set the desired number of hours, press several times or hold it in.
2. Press . The timer counts down and the dishwasher starts after the selected delay.



If you want to cancel the Delayed start option, press and hold  for three seconds.

### **Start/Stop**

Close the door properly, otherwise the dishwasher will not start. Press  until the display shows "Program started".

If the dishwasher is not started within 2 minutes of the last button press, the machine switches off.

### **Stopping or changing a program**

In order to not accidentally press a button and cancel the current program, you must press and hold  for three seconds if you want to change the program after starting the dishwasher. Add more detergent if the lid of the detergent dispenser has opened. Then choose a new program and press .

### **Time remaining**

Once you have chosen a program, a program mode and options, the time the program took when last used is displayed.

Once you have started the dishwasher, the display shows the remaining program time. The remaining time is updated during the drying phase.

This may differ somewhat from time to time depending on the temperature of the water supply, the amount of dishes, the ambient temperature and other factors.

During the first run of each program, the remaining time displayed can be slightly misleading, as the dishwasher is estimating the time. When you run the program a second time, the dishwasher will calculate the remaining time based on the previous duration of the program.

## If you want to load more dishes<sup>4)</sup>

Open the door. The dishwasher stops automatically. Add the dishes and close the door. After a while, the dishwasher continues the program.

## Power failure

If the dishwasher is turned off due to a power failure when a dishwashing program is running, the program continues when power is restored. If the power is cut during drying, the program is interrupted.

If you open the door for more than 2 minutes during drying, the program will be interrupted.

## Once the program has finished

Once the program has finished, "Program done" appears on the display.

At the end of the program, you will hear a short beep. Chapter *Settings* describes how to change this function.

The dishwasher switches off automatically after the program ends. Turn off the water tap after each use.

## For the best drying results

- Fully load the dishwasher.
- Angle dishes with hollows, such as cups, so that the rinse water will run off. This is also important for plastic items.
- Top up with rinse aid or increase the rinse aid dose setting.
- Activate the Auto door open option.
- Allow the dishes to cool before unloading the dishwasher.













## Unloading the dishwasher

Hot porcelain is more fragile. Leave the dishes to cool in the dishwasher before unloading them.

Unload the lower basket first to avoid any water drops from the upper basket falling onto the dishes in the lower basket.

<sup>4)</sup> You should not load more dishes if the lid of the detergent dispenser has been opened.

# Program chart

Program	Program mode / Option	Number of prewashes	Main wash	Number of rinses	Final rinse	Dishwashing time (approx. hrs:min)	Consumption values <sup>1)</sup> Energy (approx. kWh)	Water cons. (liter)
 Eco 2)	 3)	1	52 °C	2	39 °C	2:48	0.59	10.1
 Heavy	 3)	1	65 °C	2	60 °C	2:45	1.2	11.0
 Intensive		2	70 °C	2	65 °C	2:50	1.6	15.5
 Quick	 3)		65 °C	3	65 °C	1:30	1.3	14.0
 Time program		0-2	≤65 °C	2	≤65 °C	0:15-2:30	0.3-1.4	9.5-16.0
 Hygiene			70 °C	2	65 °C	1:05	1.3	10.0
 Rinse and hold				1		0:07	0.01	3.5
 Self-cleaning			70 °C	2	65 °C	1:05	1.0	9.5
 Anti-odour						72:00	0.2	



- 1) Consumption values vary depending on the temperature of the incoming water, room temperature, load size, selected additional functions and more.
- 2) The energy label performance figures are based on this program which is recommended for normally soiled load at the rated capacity (Option: Auto door open).
- 3) Auto door open

Press .



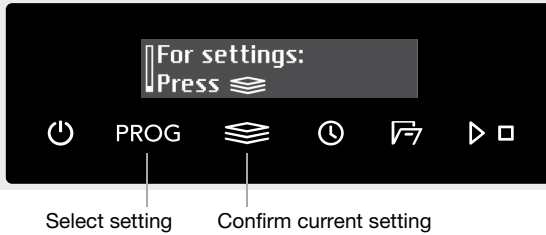

To open the dishwasher Settings menu, press **PROG** until  Settings menu is shown on the display and confirm your selection with .

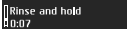
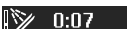
To exit the dishwasher's Settings menu, select Exit and confirm your selection with .



Settings	Alternatives	
1. <b>Language</b>		You can choose the language used for the display.
2. <b>Automatic child lock</b>	<i>On/Off</i>	You can activate the Automatic child lock setting to prevent children from starting the dishwasher. To temporarily deactivate or activate the Automatic child lock setting, press and hold  for  three seconds.
3. <b>Display</b>	Logotype <i>On/Off</i>	Setting to hide the logo shown on the display.
	Contrast <i>1/2/3/4</i>	For adjusting the contrast of the display.
	Program Info screen <i>T/S</i>	You can select which information is shown on the display.  T-Text (Text)  S-Symbol (Symbol)
4. <b>Sound</b>	Feedback <i>0/1/2/3</i>	A beep confirms that the display has been pressed.
	Notification <i>0/1/2/3</i>	The buzzer indicates when a dishwashing program has ended. <i>Error messages are always indicated by a loud buzzer.</i>
5. <b>Rinse aid</b>	<i>0/1/2/3/4/5</i>	Setting for rinse aid dosage. The rinse aid dispenser can be adjusted between 0 (Off) and 5 (High dosage). Increase the rinse aid dosage:

# Settings

Settings	Alternatives	
		<ul style="list-style-type: none"> <li>If the dishes have water marks.</li> </ul> <p>Decrease the rinse aid dosage:</p> <ul style="list-style-type: none"> <li>If the dishes have a sticky white/blue film.</li> <li>If the dishes are streaked.</li> <li>Build-up of foam. If you have very soft water, the rinse aid can be diluted 50:50 with water.</li> </ul>
6. <b>TAB</b>	<i>On/Off</i>	<p>Activate this setting when using an all-in-one detergent that contains rinse aid.</p> <p>This setting reduces the rinse aid dose.</p>
7. <b>Super rinse</b>	<i>On/Off</i>	<p>The Super rinse function rinses the dishes an extra two times.</p> <p>The program time is extended and the dishwasher uses more energy and water.</p> <p><i>Activated in the following programs:</i></p> <p><i>Heavy</i></p> <p><i>Intensive</i></p> <p><i>Quick</i></p> <p><i>Hygiene</i></p>
8. <b>Odour control</b>	<i>On/Off</i>	<p>When Odour control is activated,  Anti-odour can be selected from the program table.</p>
9. <b>Failure readout</b>		<p>Any error messages.</p> <p><i>When contacting your service centre, you may be asked to provide the most recent error messages.</i></p>
10. <b>Factory reset</b>		<p>Restores all settings to the factory defaults.</p> <p>Select Factory reset and press  .</p>
11. <b>Exit</b>		<p>To exit the dishwasher Settings menu, select Exit and press .</p>

## \* Top up rinse aid

When the rinse aid needs topping up, the above symbol lights on the display.

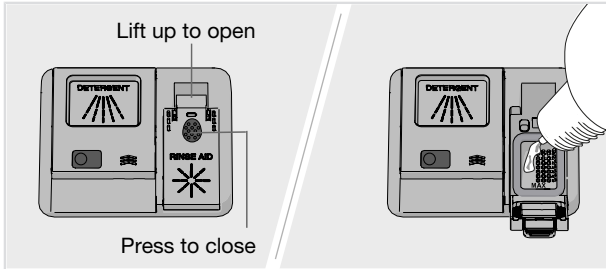

1. Open the rinse aid compartment lid.
2. Carefully top the rinse aid up to the marked level **MAX**.
3. Wipe up any splashes of rinse aid around the compartment.
4. Close the lid firmly.

After topping up, it may take a while before the symbol goes out.

### NOTE!

For water with a hardness greater than 10–12 °dH, you ought to use rinse aid with citric acid (known as acid rinse aid).

## Clean the filters

### Coarse filter

The coarse filter traps larger food particles, which cannot get past the drainage pump. Empty the coarse filter when necessary. It should be cleaned at regular intervals depending on how often the dishwasher is used.

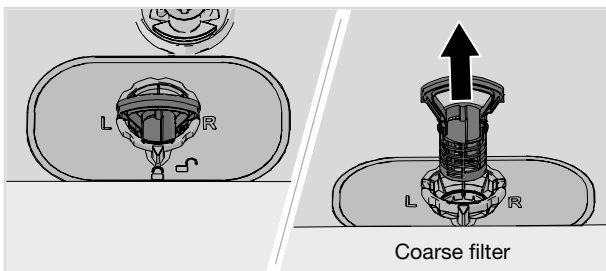

1. Lift the coarse filter by the handle.
2. Empty the coarse filter.
3. Refit the coarse filter. Press it down until it clicks into place.

# Care and cleaning

## Fine filter

Debris that collects on the fine filter is automatically rinsed away during each wash. Clean the fine filter when necessary. It should be cleaned at regular intervals depending on how often the dishwasher is used.

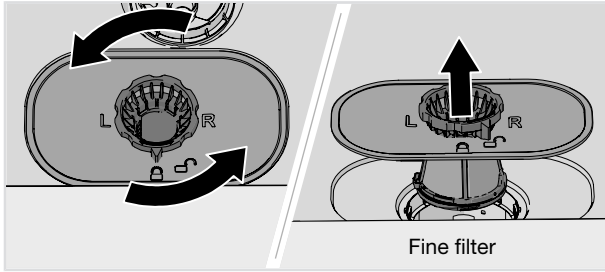

1. Turn the locking ring anticlockwise and lift the fine filter straight up.
2. Clean the fine filter.
3. Refit the fine filter and turn the locking ring clockwise to its stop position. Check that the edges seal properly.

Remember to refit the coarse filter!

## NOTE!

Dishwashing results may be affected if the coarse and fine filters are incorrectly fitted. The dishwasher must not be used without the filters in place!

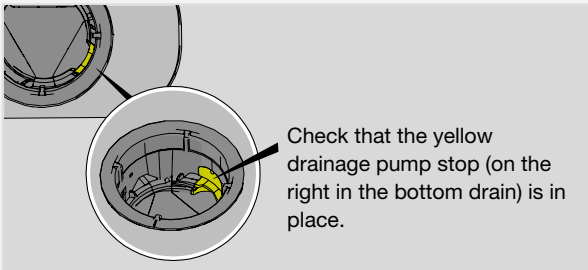



## Cleaning the spray arms

Holes and bearings can sometimes become blocked. Remove any debris using a pin or something similar. The spray arms also have holes on their undersides.

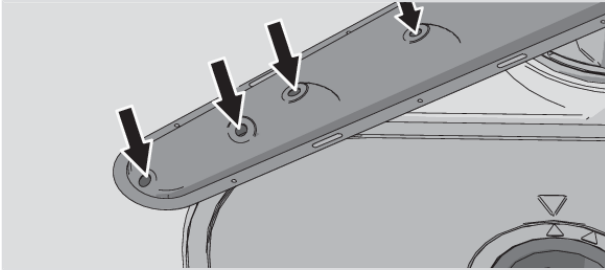

To facilitate cleaning, you can remove the spray arms. Remember to fit them firmly back into place after cleaning.

### Upper spray arm

- Pull out the upper basket.
- Unscrew the spray arm bearings counterclockwise to remove the spray arm from the upper basket.

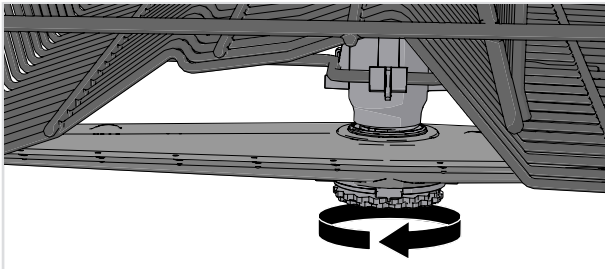

### Lower spray arm

- Pull the lower spray arm straight up to release it.

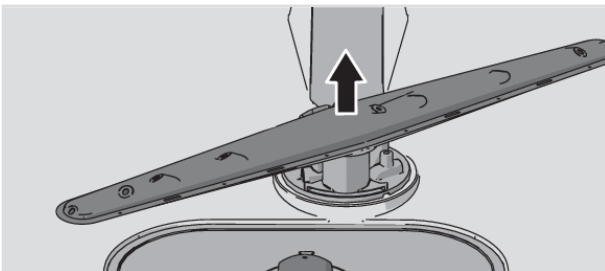

# Care and cleaning

## Clean the outside of the dishwasher

### Door and door seal

Open the door. Clean the sides of the door and the door seal regularly with a slightly damp cloth. Clean the door seal at the lower front edge of the dishwasher with a washing-up brush.

### Display

Keep the display and the buttons clean. If necessary, wipe them with a dry or slightly damp cloth. Never use cleaning products – they may scratch the surface.

## Run Self-cleaning

### Dishwasher tub

The dishwasher tub is made of stainless steel and is kept clean through normal use (when used regularly).

If you have hard water, limescale deposits may build up in the dishwasher. If this happens, run the Self-cleaning program with two tablespoons of citric acid in the detergent compartment (with no dishes in the machine). Special dishwasher cleaners are also available on the market.

## Remove blockages

### Unblocking the drainage pump

If the dishwasher still contains water after the program has finished, something may be blocking the drainage pump, which results in the error message Water outlet fault or BLDC drain pump fault.

1. Turn the machine off using  and remove the plug from the wall socket.
2. Remove the coarse filter and the fine filter.
3. Scoop out the water from the dishwasher tub.
4. In order to inspect the drainage pump, remove the yellow drainage pump stop on the right in the bottom drain. (Use a pair of pliers if necessary.)
5. Turn the pump wheel located behind the drainage pump stop by hand. Carefully remove any items.
6. Refit the drainage pump stop along with the fine and coarse filters.
7. Plug the machine in again.

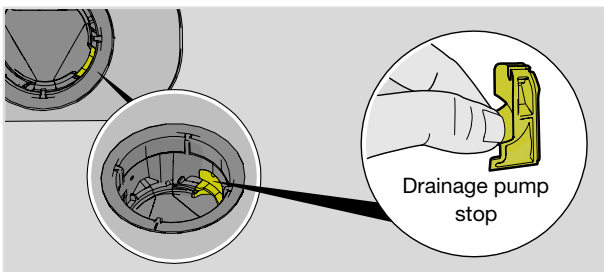

### NOTE!

Do not forget to refit the drainage pump stop.

## Unblocking the inlet hose filter

If the water supply contains small particles, the outer filter on the inlet hose may become blocked, which results in the Water inlet fault error message.

1. Turn the machine off using  and remove the plug from the wall socket.
2. Turn off the water tap.
3. Unscrew the inlet hose.
4. Carefully remove the outer filter from the inlet hose and clean it.
5. Refit the filter and check that the gasket is correctly positioned.
6. Screw the inlet hose firmly into place.
7. Plug the machine into the wall socket and turn on the water tap. Allow the pressure to settle for a while and check that the connection is watertight.

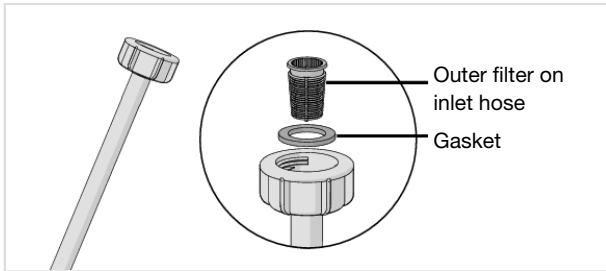

# Troubleshooting

Error messages		Action
<b>F10</b>	Overfilling water 1	Unblocking the drainage pump. See the chapter, <i>Care and cleaning</i> . If the problem persists, contact your nearest service centre.
<b>F11</b>	Water outlet fault	See "Water remains in the dishwasher" under "Problem" in the table below. If the problem persists, contact your nearest service centre.
<b>F12</b>	Water inlet fault 1	<p>Check whether dishwasher inlet hose is connected to a pressure limiting valve (some pressure limiting valves may restrict the supply of water to the dishwasher).</p> <p>Check that the water tap is on. Check that the outer filter on the inlet hose is not blocked. See <i>Unblocking the inlet hose filter</i> in the chapter, <i>Care and cleaning</i>. If the problem persists, contact your nearest service centre.</p>
<b>F40</b>	Inlet valve leakage	Turn the water tap off and contact your nearest service centre.
<b>F41</b>	Heater fault 1	Turn the water tap off. Remove the plug from the wall socket and contact your nearest service centre.
<b>F45</b>	Diverter fault	Contact your nearest service centre.
<b>F52</b>	Water level fault	Clean the coarse and fine filters. Check that the outer filter on the inlet hose is not blocked. If the problem persists, contact your nearest service centre.
<b>F54</b>	Overfilling water 2	<p>Turn the water tap off and contact your nearest service centre.</p> <p>To avoid water leaking outside the dishwasher, do not remove the plug from the wall socket until the water tap on the supply line has been turned off!</p>
<b>F56</b>	Circulation pump fault	Contact your nearest service centre.
<b>F67</b>	Water inlet fault 2	<p>Check whether dishwasher inlet hose is connected to a pressure limiting valve (some pressure limiting valves may restrict the supply of water to the dishwasher).</p> <p>Check that the water tap is on. Check that the outer filter on the inlet hose is not blocked. See <i>Unblocking the inlet hose filter</i> in the chapter, <i>Care and cleaning</i>. If the problem persists, contact your nearest service centre.</p>
<b>F68</b>	BLDC drain pump fault	See "Water remains in the dishwasher" under "Problem" in the table below. If the problem persists, contact your nearest service centre.

Press any button to clear the error message.

Problem	Possible causes	Action
The display does not react when pressed.	You have pressed the display too soon after opening the door.	Wait a moment then try again.
	Child lock or Automatic child lock is activated.	See the chapter <i>Safety instructions</i> .
	Dirt on the display.	Clean with a dry or slightly damp cloth.
Cannot close door.	The baskets are not correctly positioned.	<p>Check that the baskets are correctly positioned horizontally.</p> <p>Check that the dishes are not blocking the baskets from sliding properly into place.</p>
	The door lock does not click into place and lock.	<p>Check the door lock. If it does not click into place and lock, open the door.</p> <p>Press and hold <b>PROG</b> and <b>↵</b> until the display starts flashing. Wait until it stops flashing (60 seconds). Close the door.</p> <p>Check that the door lock clicks into place and locks.</p>

# Troubleshooting

Problem	Possible causes	Action
The dishwasher does not start.	▶ □ has not been pressed.	Press and hold ▶ □ until the display shows "Program started".
	The door is not properly closed.	Check.
	You have opened the dishwasher to add more dishes while a program is in progress.	Close the door and wait. After a while, the dishwasher continues the program.
	The door lock has not clicked into place and locked.	<p>Check the door lock. If it has not clicked into place and locked, open the door.</p> <p>Press and hold <b>PROG</b> and <b>↵</b> until the display starts flashing. Wait until it stops flashing (60 seconds). Close the door. Check that the door lock clicks into place and locks and that the dishwasher starts.</p>
	Check that the Delayed start option has been selected.	Press and hold ▶ □ for three seconds if you want to cancel the Delayed start option.
	The plug is not plugged into the wall socket.	Check.
	A fuse/circuit breaker has been tripped.	Check.

Problem	Possible causes	Action
The dishes are not clean.	The spray arms do not rotate.	Check that the dishes are not blocking the spray arms.
	Spray arm holes or bearings blocked.	Clean the spray arms. See Chapter <i>Care and cleaning</i> .
	Unsuitable dishwashing program.	Select a program with a high temperature to dissolve grease on very dirty dishes, such as Intensive.
	Incorrect detergent dosage.	Dose according to water hardness. Far too much or far too little detergent results in poorer dishwashing results.
	Old detergent. Detergent is a perishable product.	Avoid large packages.
	Dishes loaded incorrectly.	Do not cover porcelain with large bowls or similar. Avoid placing very tall glasses in the corners of the baskets. See the chapter, <i>Loading the dishwasher</i> .
	Glasses and cups have toppled over during the program.	Place dishes to sit steady.
	The filters are clogged.	Clean the coarse and fine filters.
	The filters are not fitted correctly.	Check that the filters are fitted correctly. See the chapter, <i>Care and cleaning</i> .
Spots on stainless steel or silver.	Drainage pump stop missing.	Check that the yellow drainage pump stop (on the right in the bottom drain) is in place. See the chapter, <i>Care and cleaning</i> .
	Some foodstuffs, such as mustard, mayonnaise, lemon, vinegar, salt and dressings, can cause spots on stainless steel if left for too long.	Rinse off these types of foodstuffs if not starting the dishwasher immediately. Use the Rinse and hold program.
	All stainless steel can cause spots on silver if they come into contact during dishwashing. Aluminium can also cause spots on dishes.	In order to avoid marks and tarnishing, separate dishes made from different metals, such as silver, stainless steel and aluminium.

# Troubleshooting

<b>Problem</b>	<b>Possible causes</b>	<b>Action</b>
Spots or films on the dishes.	Incorrect rinse aid dosage setting.	See the chapter <i>Settings</i> .
	The setting TAB is activated and all-in-one detergent with insufficient drying effect is being used.	Change all-in-one detergents or deactivate the TAB setting and top up with separate rinse aid. See Rinse aid in the chapter, <i>Settings</i> .
	Too high temperature and/or too much detergent can cause etching on crystal. Unfortunately, this cannot be repaired, only prevented.	Wash crystal at a low temperature and with a conservative amount of detergent. Contact the detergent manufacturer.
The dishes have a sticky white/blue film.	Rinse aid dosage setting too high.	Reduce the dosage. See the chapter <i>Settings</i> . If you have very soft water, you may want to dilute the rinse aid 50:50 with water.
Spots left after washing.	Lipstick and tea/coffee stains can be difficult to remove.	Use a detergent with a bleaching agent.
Detergent residue in the detergent compartment after dishwashing.	The detergent compartment was damp when adding detergent.	The detergent compartment must be dry when adding detergent.
	The detergent compartment is blocked.	Check that the dishes are not preventing the detergent compartment from opening.
Rattling sound when dishwashing.	The dishes are not correctly placed or the spray arms are not rotating.	Check that the dishes are placed securely. Spin the spray arms to make sure they can rotate.
1 minute is shown for a longer period on the display.	The program is taking longer than estimated.	No action. The program time is stored and next time the program is run the corrected time will be displayed.



<b>Problem</b>	<b>Possible causes</b>	<b>Action</b>
Water remains in the dishwasher.	The filters are clogged.	Clean the coarse and fine filters.
	The filters are not fitted correctly.	Check that the filters are fitted correctly. See the chapter, <i>Care and cleaning</i> .
	Debris in the drainage pump.	Clean the drainage pump. See the chapter <i>Care and cleaning</i> .
	Drainage pump stop missing.	Check that the yellow drainage pump stop (on the right in the bottom drain) is in place. See the chapter, <i>Care and cleaning</i> .
	Kink in drainage hose.	Check that the hose is free from kinks and sharp bends.
	Blocked drainage hose.	Disconnect the drainage hose where it connects to the sink unit's water trap. Check that no debris has fastened and that the connection has an inner diameter of at least 14 mm.
Bad odour in dishwasher.	Dirt around the seals and in corners.	Clean with washing-up brush and low foaming cleaner.
	Low temperature programs have been selected for a prolonged period.	Run a program with a high temperature once or twice a month. Or run a self-cleaning program. See Self-cleaning in the chapter <i>Using the dishwasher</i> .
Grease deposits in the dishwasher.	Low temperature programs have been selected for a prolonged period.	Select a program with a high temperature to dissolve grease on very dirty dishes, such as Intensive. Or run a self-cleaning program once or twice a month. See Self-cleaning in the chapter <i>Using the dishwasher</i> .

# Troubleshooting

<b>Problem</b>	<b>Possible causes</b>	<b>Action</b>
The dishes are not dry enough.	The Auto door open option is not activated.	Activate the Auto door open option.
	The dishwasher is not fully loaded.	Fully load the dishwasher.
	Rinse aid needs topping up or dosage is set too low.	Top up with rinse aid or increase the rinse aid dose setting.
	The setting TAB is activated and all-in-one detergent with insufficient drying effect is being used.	Change all-in-one detergents or deactivate the TAB setting and top up with separate rinse aid. See Rinse aid in the chapter, <i>Settings</i> .

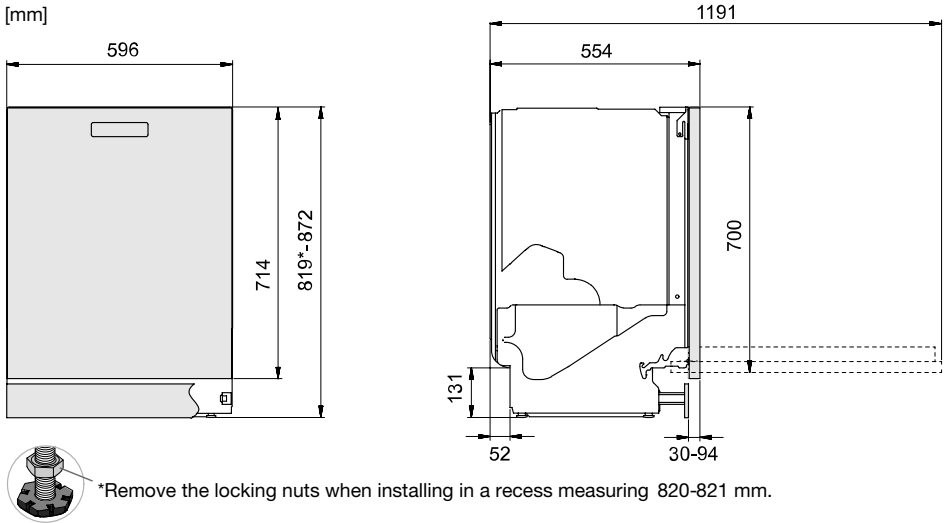

*Nominal dimensions. Actual measurements may vary.*

## Safety instructions

- Connections to electricity, water and drainage must be performed by a qualified professional.
- Always follow applicable regulations for water, drainage and electricity.
- Take care during installation! Wear protective gloves! There must always be two people!
- Before screwing the dishwasher into place, test the dishwasher by running the Rinse and hold program. Check that the dishwasher fills with water and drains. Check also that none of the connections leak.

### WARNING!

The ventilation opening in the lower part of the door must not be blocked by a rug, carpet or similar furnishing.

### WARNING!

Turn off the water supply when installing the dishwasher!

The plug must be disconnected or power to the socket turned off while the work is carried out!

# Installation

## Transport protection for the door

Do not forget to remove the transport protection for the door when unpacking the dishwasher.

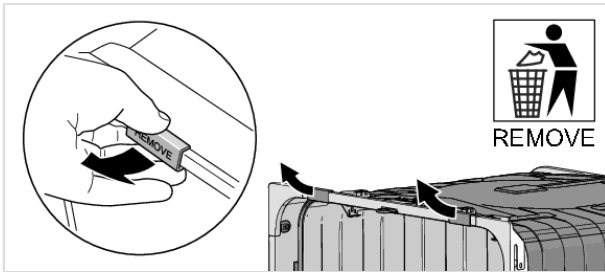

## Placing the dishwasher

The dishwasher is intended for installation under a worktop. The recess dimensions are illustrated. Holes for wires/cables need not be larger than 38 mm in diameter. Make sure the edges of such holes are even to prevent damage to the drainage and inlet hoses and the power cable.

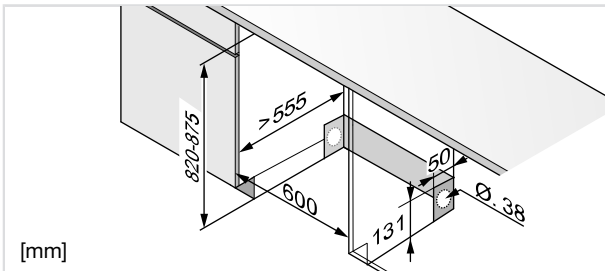

If the dishwasher is built-in the surrounding cabinetry must be resistant to any condensation from the dishwasher.

### Accessory

Buy an accessory kit for freestanding installation (two side panels, a worktop and two anti-tip brackets). If the dishwasher is placed so that one of the sides is visible, side panels must be fitted. If the dishwasher is completely freestanding, both side panels, a worktop and anti-tip brackets must be fitted. Accessories can be purchased from where you bought the dishwasher.

## Affix the protective film

Mount the protective film beneath the worktop and up around the edge. The function of the protective film is to protect the worktop from moisture. (The protective film is in the enclosed plastic bag.)

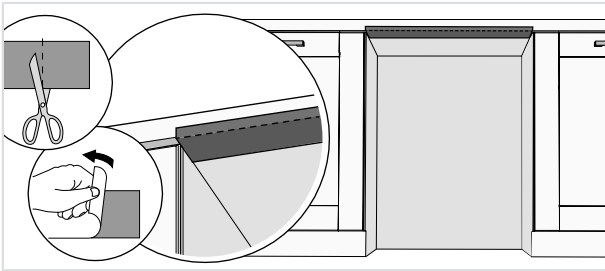

## NOTE!

The surface to which the protective film is affixed must be clean and dry.

## Adjust the height and slide the dishwasher into place

1. Start by measuring the height from the floor to the bottom edge of the worktop.
2. Measure the height from the floor to the top edge of the dishwasher.
3. Lean the dishwasher forwards a little and adjust the rear foot with the screw at the front of the dishwasher. Turn clockwise to lower or anticlockwise to raise.

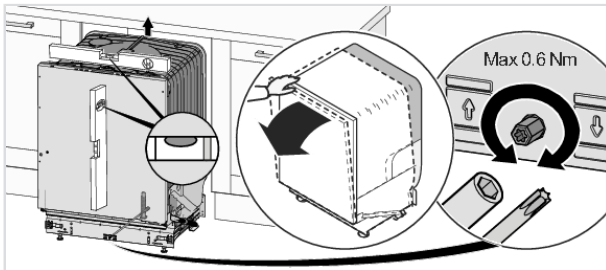

4. Adjust the front feet by turning them clockwise to raise and anticlockwise to lower the dishwasher.

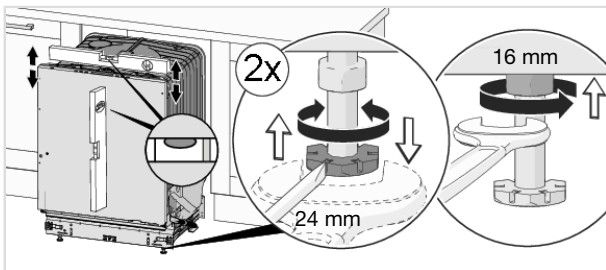

5. Check that there is an air gap of at least 3 mm between the underside of the worktop and the top edge of the dishwasher.
6. Slide the dishwasher into place.
  - Pull the supply and drainage hoses and the power cord when sliding the dishwasher into place.

# Installation

- Check that the drainage hose has no kinks or sharp bends. Also check that there is nothing that can damage the hoses.

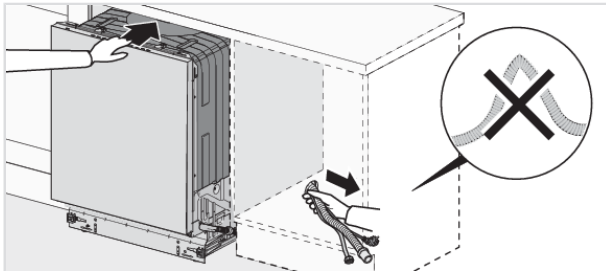

- Check that the machine is installed such that the door opens freely, otherwise door lock functionality may be disrupted.

7. Make any final adjustments to the feet and tighten the lock nuts on the front feet.

## Drainage connection

This dishwasher is suitable for installing in a raised recess (to attain an ergonomic working height). This means that the dishwasher can be placed so that the drainage hose runs to a lower level than the bottom of the dishwasher, such as by routing it directly to a floor drain.

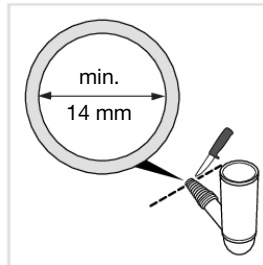
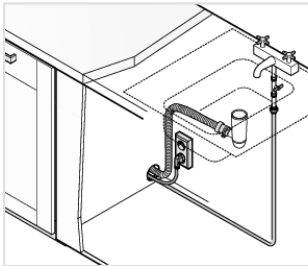

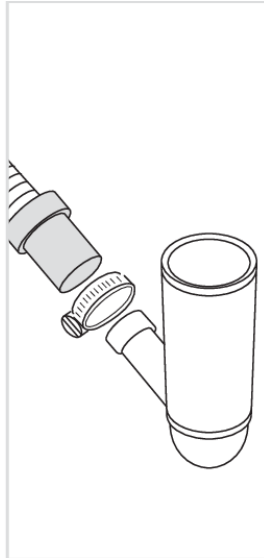
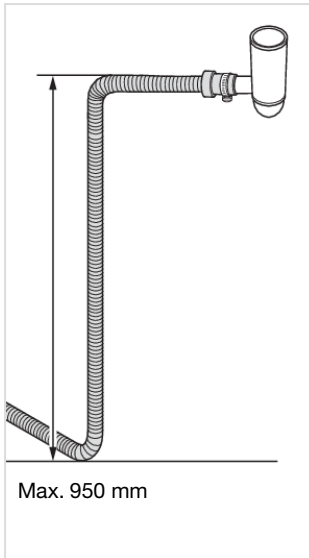

The drainage hose can also be connected to a connection nipple on the sink unit's water trap. The connection nipple must have an internal diameter of at least 14 mm.

The drainage hose may be extended by a maximum of 2.5 m (the total length of the drainage hose must not exceed 4.5 m). Any joints and connecting pipes must have an internal diameter of at least 14 mm. However, the drainage hose should ideally be replaced with a new hose without joints.

No part of the drainage hose may be more than 950 mm above the bottom of the dishwasher.

Attach the drainage hose with a hose clamp. Ensure that the drainage hose has no kinks.

## Connection to water supply

Use only the inlet hose supplied with the dishwasher. Do not re-use old or other spare hoses.

The supply pipe must be fitted with a water tap (stopcock). The water tap must be easily accessible, so that the water can be shut off if the dishwasher has to be moved.

Once the installation is complete, turn on the water tap and allow the pressure to settle for a while. Check that all connections are watertight.

### NOTE!

Only cold water connection is suitable for this appliance.

The water pressure must be between 0.03 and 1.0 MPa.

Connecting a dishwasher to the water supply via certain types of pressure limiting valves may restrict the water supply! This may cause the error message "Water inlet fault" to be displayed.

If the water pressure is higher than 1.0 MPa a pressure limiting valve must be fitted.

# Installation

## Electrical connection

Information about the electrical connection can be found on the compliance plate. This specification must match the electricity supply.

The dishwasher must be connected to an earthed wall socket.

The electric wall socket must be placed outside of the installation area to be easily accessible after installing the dishwasher. Do not use an extension cord!

## Screwing the dishwasher into place

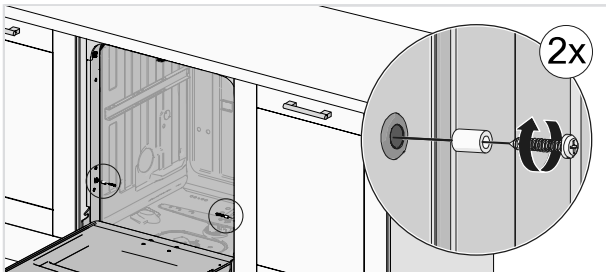
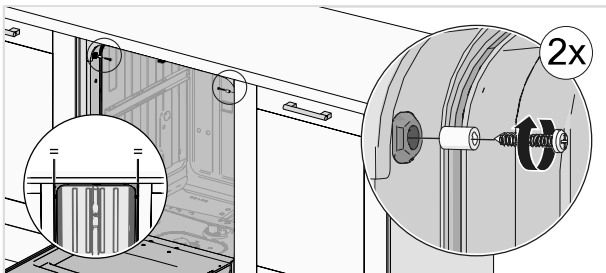

After fastening the machine, check that the front feet still touch the floor.



## Dishwasher kick panel

The dishwasher is supplied with a kick panel.

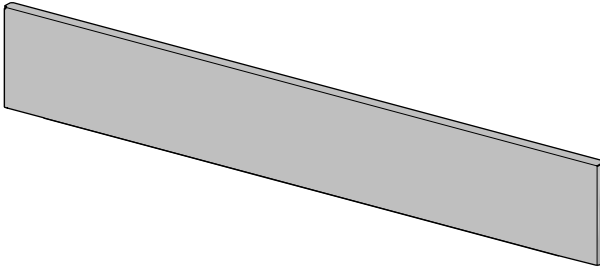

### Install the sound insulation

(only certain models)

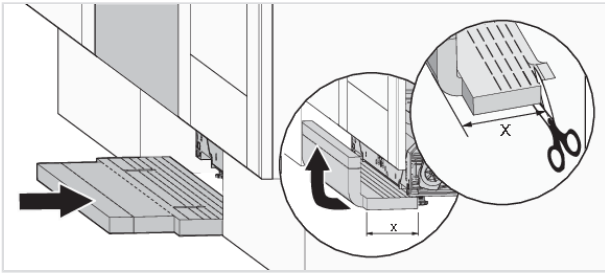

### Install the kick panel

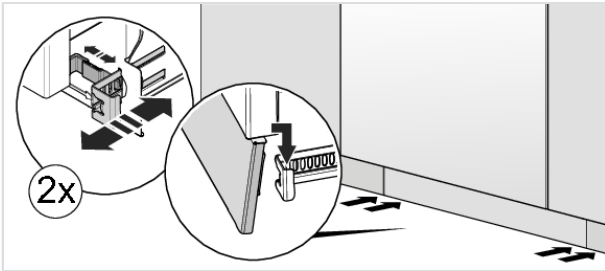

## Information about your product

There is a QR code on the compliance plate. Scan the code to view information about your product.

## Contact your nearest service centre

Read the chapter *Troubleshooting* before contacting the service centre. If you have encountered a problem that you cannot resolve, please contact your nearest service centre for professional help. See [www.asko.com](http://www.asko.com).

When making contact, provide the details on the serial number plate. Include the article number (1) and the serial number (2).

Please note that non-professional repairs may risk user safety and affect the warranty.

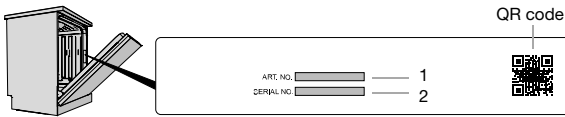

## Number of cycles

Press and hold **PROG** and  for 3 seconds to show Number of cycles on the display.

## Information on energy labelling

Australian standard:	AS/NZS 2007
Number of place settings:	14
Dishwashing programs:	Eco <sup>1)</sup> , Auto door open
Program time:	2:48 hours:minutes
Connection:	Cold water 20 °C
Test method for noise measurement:	IEC 60704-2-3

<sup>1)</sup> *This dishwashing program is the standard cleaning cycle used to compile the energy labelling information. It is intended for washing normally dirty dishes at the rated capacity and is the most effective program in terms of combined energy and water consumption.*

## Technical data

Height:	819-872 mm
Width:	596 mm
Depth:	554 mm
Weight:	45 kg <sup>1)</sup>
Water pressure:	0.03-1.0 MPa
Electrical connection:	See compliance plate
Rated power:	See compliance plate

<sup>1)</sup> *Weight can vary due to different specifications.*

## Information for test institute

Request test institute information via e-mail [dishwashers@appliance-development.com](mailto:dishwashers@appliance-development.com).

The request should include the details on the product's serial number plate. Include the article number (1) and the serial number (2).



# ASKO

Inspired by Scandinavia

[WWW.ASKO.COM](http://WWW.ASKO.COM)



874270-a3



*We reserve the right to make changes.*